



For Planners, Architects and Operators
Air Handling Units for Pools



Air Handling Units for Pools

First choice for pools – compact to customised

Dehumidification for pros – custom pool equipment

Multifunctional individual pool air handling units from WOLF. Available in 18 standard sizes for indoor and outdoor installation with an air flow rate of 2,000 to 35,000 m³/h. Numerous options and configuration versions available on request. In addition to the 18 standard sizes, units can also be constructed to meet specific requirements for renovation, restoration and other demanding projects.



- Equipped with cutting edge cooling technology
- Integrated control with interactive interface for the best possible operation of the WOLF pool unit
- Resistant to corrosion: fully coated
- Optional pool water condenser for additional pool water heating
- High quality components with maximum corrosion protection, e.g. polypropylene or aluminium heat exchangers

Physical housing properties in accordance with DIN EN 1886

Thermal insulation:	T2
Thermal bridge factor:	TB2
Leakage:	L1
Deflection:	D1
Filter bypass leakage:	F9

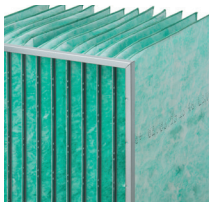
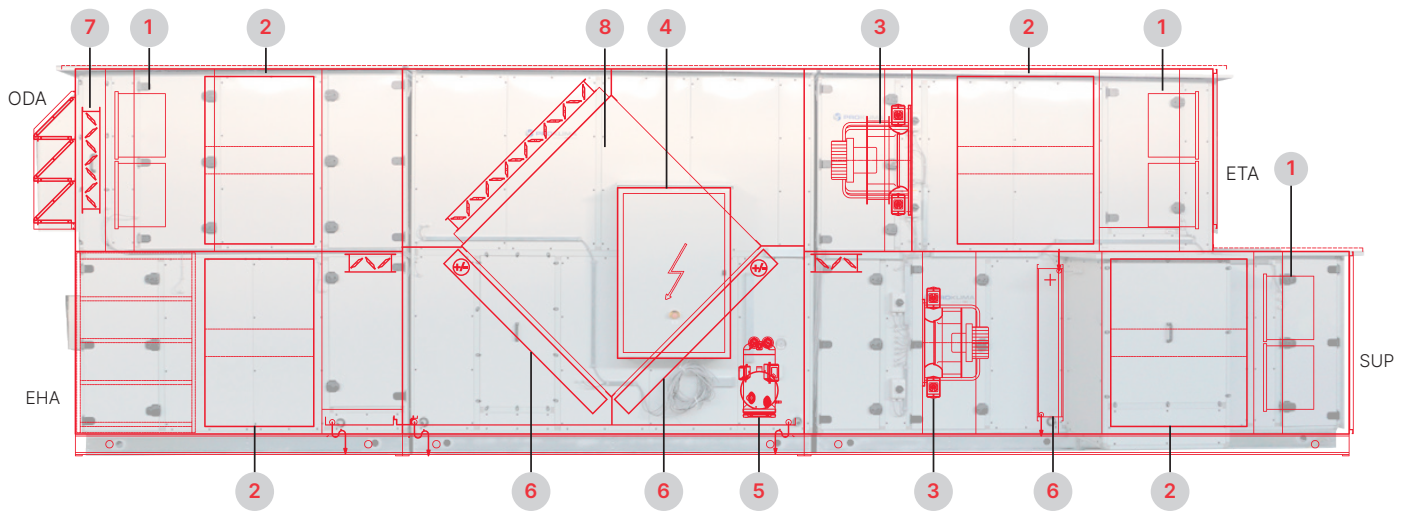

1 Bag filter
(optional panel filter also available)



5 Highly efficient inverter-controlled heat pump for switching between heating and cooling

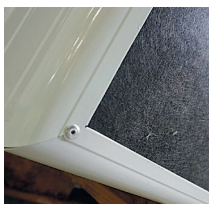

2 Silencers which do not absorb or store moisture

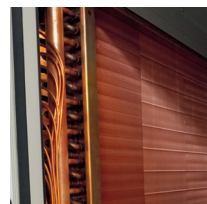

6 Copper condensers and evaporators for maximum corrosion resistance

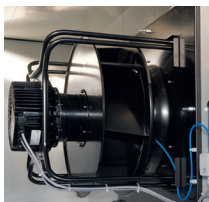

3 Fans with EC motor and integrated flow rate detection system



7 Dampers made from anodised aluminium

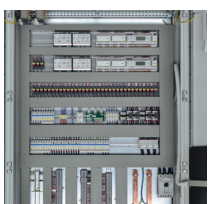

4 Full cabling, including control panel and controller specifically designed for the unit



8 Highly efficient heat recovery system

Plug & play for pools - CKL Pool

The new CKL Pool was specially designed for intelligent conditioning of small indoor swimming pools. It reduces high humidity levels and supplies a flow of dry air. Full integration of the refrigerant circuit and control system makes selection, installation and commissioning incredibly easy.

Physical housing properties in accordance with DIN EN 1886

Thermal insulation:	T2
Thermal bridge factor:	TB2
Leakage:	L1
Deflection:	D1
Filter bypass leakage:	F9

The new CKL Pool at a glance:

- Fully integrated heat pump and control unit as a single, complete system
- Coolant is prefilled
- Robust indoor unit, particularly easy to install and maintain
- Meets VDI 6022 and VDI 3803 requirements
- High efficiency thanks to heat recovery system and EC fans
- Two models are available, featuring compact dimensions and a nominal flow rate from 2,000 m³/h to 3,000 m³/h
- Resistant to corrosion: fully coated
- Compatible with the WOLF SmartSet system for easy connection to smartphones and browsers — locally or online
- Optional pool water condenser
- Unit is fully wired for fast, straightforward commissioning



Smartset

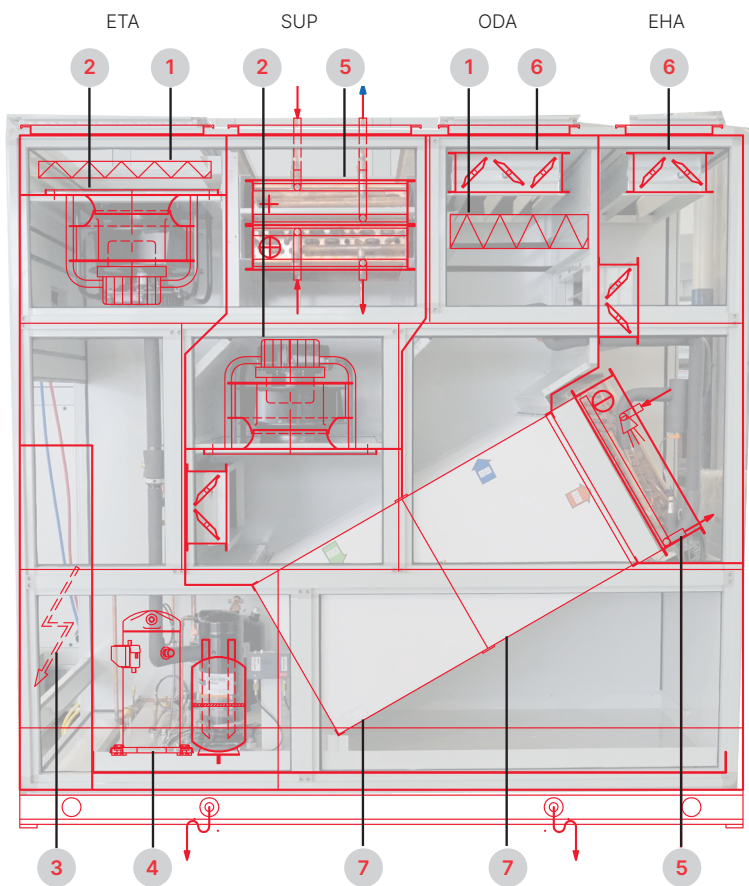

- 1 Panel filter
- 2 Fans with EC motor and integrated flow rate detection system
- 3 Full cabling, including control panel and controller specifically designed for the unit
- 4 Highly efficient heat pump with digital scroll compressor
- 5 Copper condensers and evaporators for maximum corrosion resistance
- 6 Dampers made from anodised aluminium
- 7 Efficient heat recovery system made of corrosion-resistant polypropylene

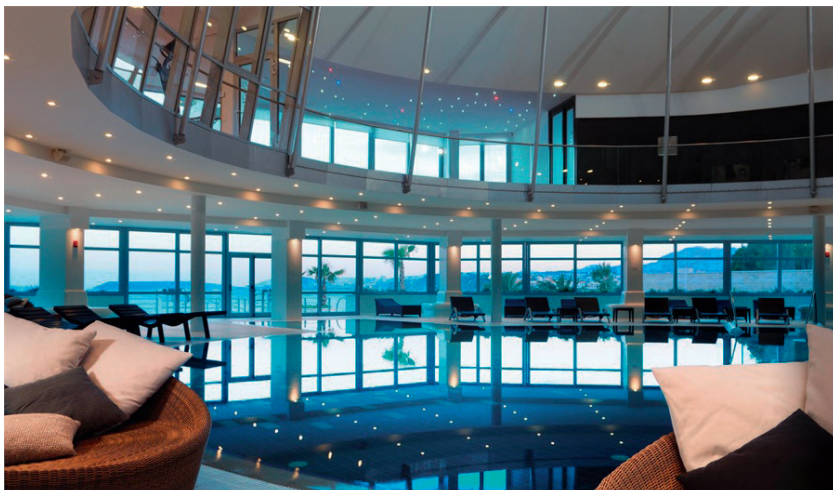

Everything in hand – with automatic controls

Connect & get going:

The factory-tested, fully cabled control panel, a DDC control unit and all necessary field devices come pre-installed. WOLF has developed software specifically for pool applications to ensure that these components work together perfectly.

The software was also tailored to meet specific dehumidification requirements in order to prevent condensation and keep the air within the limits required for an optimal microclimate. All of the relevant parameters can be adjusted to meet the requirements of your project.

Direct browser-based access allows you to control the unit remotely. This can be used to change operating modes, record data or make detailed changes.

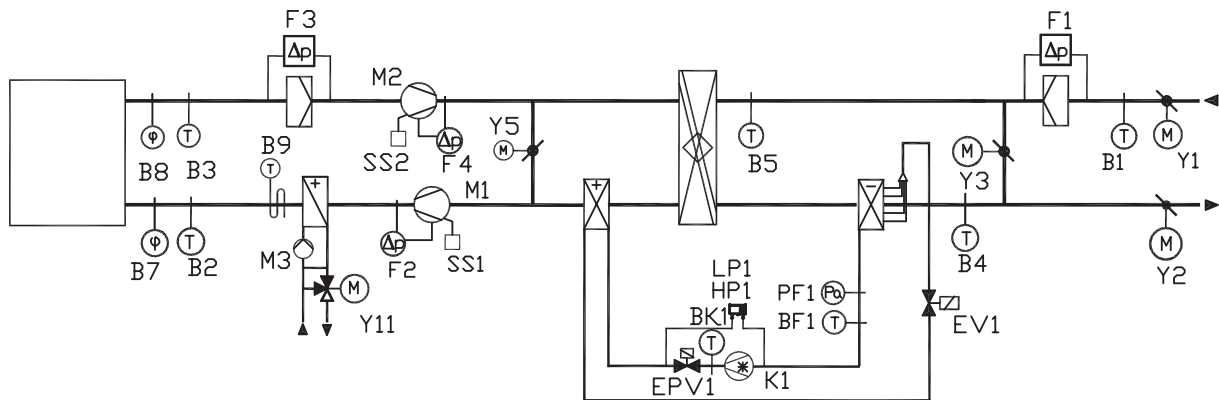

VDC	Fire alarm signal
B1, B2, B3, B4, B5	Duct temperature sensor
B7, B8	Duct humidity sensor
B9	Frost stat
F1, F3	Differential pressure switches
F2, F4	Air volume sensor
Y1	Damper drive
Y2	Damper drive
Y3	Damper drive
Y5	Damper drive
Y11	Servomotor
SS1, SS2	Repair switch

M1, M2	Supply air / extract air fan
M1, M2	Supply air / extract air fan
M3	Heating circuit pump
K1	Compressor
HP1, LP1	High pressure/low pressure protection
EPV1	Electromagnetic valve
EV1	Electric expansion valve
PF1	Coolant pressure sensor
BF1	Coolant temperature sensor
BK1	Compressor temperature sensor

* This plan is an example. Actual plans will vary depending on the options which are selected.

1. Safe and optimal operation

- a. Temperature and moisture control with minimum and maximum thresholds for supply air
- b. Energy-efficient integrated heat pump control for dehumidification
- c. Mixer valve control on heater for optimal supply air
- d. Heat recovery system with “Maximum Economy Changeover” (with optional bypass)
- e. Control of supply and extract air fans by means of differential pressure sensors or by measuring the external pressure drop
- g. Fan imbalance control
- h. Heat pump activation at low outside temperatures

2. Various modes and programs available

- a. 7-day program with holiday and special day programs
- b. Day/night setting
- c. Boost damper to quickly heat supply air before bathing
- d. Dehumidification using outside air for free cooling
- e. Optional control of pool water condenser and pool water heating functions

3. Interfaces

- a. Connection to building management systems possible (using MODBUS for communication)
- b. Optional interfaces: BACNet, BACNet / IP, LON, Web Module
- c. Easy access via web browser
- d. Optional remote control for wall mounting
- e. CKL Pool: Compatible with WOLF Link Pro in conjunction with a MODBUS interface



Equipped for every application: Operating modes for every season.

Operating mode

Standby mode without dehumidification (Winter)

- Heat pump inactive
- Heat recovery inactive
- Reheating coil active
- Boost damper open

Bathing with dehumidification (winter)

- Heat pump active
- Heat recovery active
- Reheating coil active if necessary
- Damper for mixed air active

Bathing with dehumidification (summer)

- Heat pump inactive
- Heat recovery active

CKL Pool

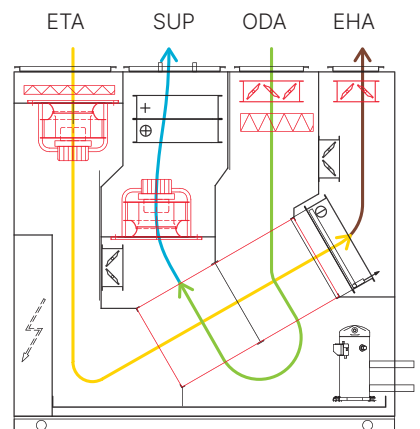
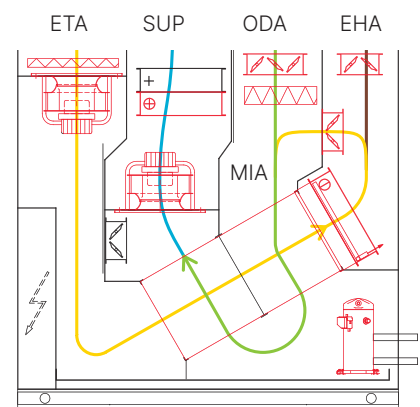
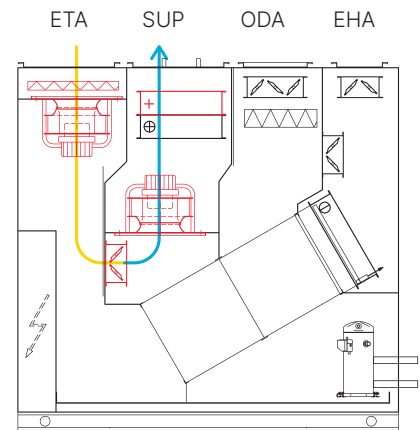

Individual pool units

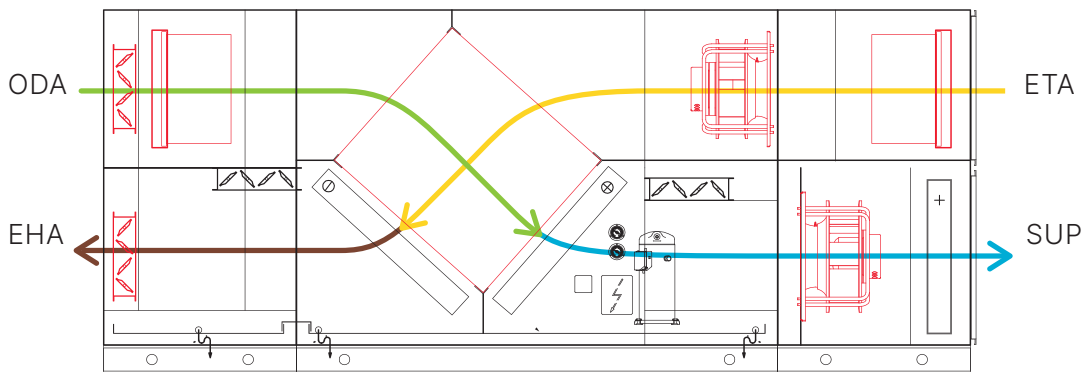
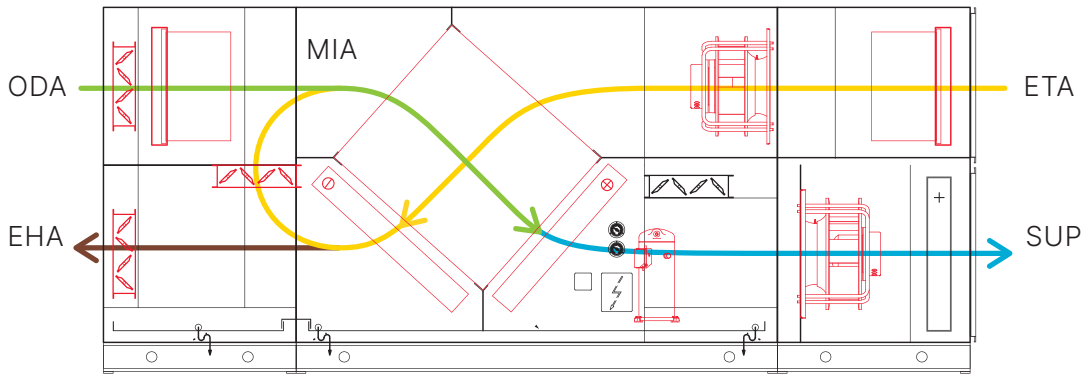
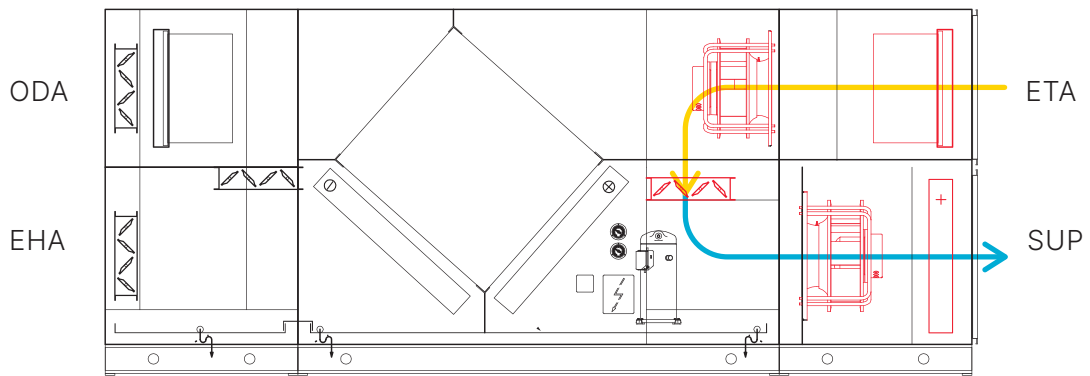

Calculations made easy. VDI Pool web app

Seconds after entering your parameters, the VDI POOL WEB-APP will perform a detailed calculation of the air volume required for the specified pool area. This calculation is based on the VDI 2089-1:2010 guidelines and the information for the air handling units developed for the specified requirements.

A professional result in just **3 steps**:



An easy way to enter the necessary parameters



Schwimmbecken ohne Attraktionen	
Schwimmbadbereich	30 °C
Lufttemperatur	
Relative Feuchte	54 %
Wassertemperatur	28 °C
Wasserfläche des Pools	50 m ²
Schwimmbecken mit Attraktionen	
Schwimmbadbereich	30 °C
Lufttemperatur	
Relative Feuchte	55 %
Wassertemperatur	28 °C
Wasserfläche des Pools	0 m ²
Kanal mit zusätzlichen Attraktionen	
Schwimmbadbereich	30 °C
Lufttemperatur	
Relative Feuchte	54 %
Wassertemperatur	28 °C
Länge des Kanals	0 m
Attraktionen	
Art der Name:	Menge
Strömungskanal	0
Wasserpilz	1
Gegenstromschwimmanlage	0
Nacknmassagedusche	2
Unterwasserdüsen	5
Sprudelbrunnen	0
Geysir	0
Kinderrutsche (10m)	0
Massagezone	0
Liegestühle	0
Sitze	0
Prüfung min. Luftwechsel	
Raumvolumen	2000 m ³
Min. Luftwechsel	5 LW/h
Berechnen	



The configurator suggests a unit based on your requirements

LUFTVOLUMENSTROMBERECHNUNG LAUT VDI 2089

Ergebnisse - verdampfte Wassermassenstrom [kg / h]

Schwimmbeckentyp	Abgeschlossen	Min. geöffnet	Max. geöffnet
Schwimmbad ohne Attraktionen	0,37	3,73	14,94
Schwimmbaden mit Attraktionen	0,00	0,00	0,00
Kanal mit Attraktionen	0,00	0,00	0,00
Insgesamt	0,37	3,73	14,94

Ergebnisse - Zuluftstrom

Min. Zuluftmassenstrom	2.819	kg/h
Min. Zuluftvolumenstrom	2.349	m³/h

Ergebnis - Prüfung min. Luftwechsellanzahl

Min. Zuluftvolumenstrom	10.000	m³/h
Zuluftvolumenstrom	10.000	m³/h

Minimal notwendige Luftwechselrate ist gültig ausschließlich zum Vergleich mit dem berechneten minimalen Luftvolumenstrom.
Zur Auswahl der empfohlener Gerätegröße wird ausschließlich die VDI Berechnung des minimalen Zuluftvolumenstroms herangezogen.

Empfohlene Größe des RLT-Geräts: CKL-POOL 30GC

Min. Luftstrom	Nominaler Luftstrom	Max. Luftstrom	
2000	3000	3200	m³/h

Gewählt wurde die empfohlene Gerätegröße mit dem ersten größeren nominalen Luftvolumenstrom.
Für eine genaue Festlegung des empfohlenen Modells mit dem berechneten Luftvolumenstrom, senden Sie bitte eine Anfrage an unsere Vertriebsabteilung.

Ergebnis anzeigen / Herunterladen

VDI
TD
HX
TXT
DWG
ALL

Anfrage absenden



Comprehensive support and documentation allow you to be confident about your plans

WOLF GmbH
 Industriestraße 1, D-40468 Mannheim/DE, Deutschland
 Internet: www.wolf-heattech.de

Berechnung der benötigten Lüftungsmenge zur Lüftung von Innenpools VDI 2089

Luftvolumenstromberechnung * 1

Parameter	Werte	Einheit
Schwimmbecken ohne Attraktionen	30	Art der Name
Schwimmbecken mit Attraktionen	54	Stützoberfläche
Wassertemperatur [°C]	13	Wassertemp.
Relative Feuchte [%]	54	Stützoberfläche
Wasseroberfläche des Beckens [m²]	50	Gegenschenkelverhältnis
Schwimmbecken mit Attraktionen	0	Nachmassagerüstgröße
Schwimmbecken ohne Attraktionen	0	Unterwasserleuchte
Relative Feuchte [%]	55	Spritzstrahlenergie
Wassertemperatur [°C]	28	Gips
Wasseroberfläche des Beckens [m²]	0	Kinderfläche (10m)
Kanal mit Attraktionen * 1	0	Massepunkte
Schwimmbecken mit Attraktionen	30	Legenbreite
Relative Feuchte [%]	54	Stütz
Wassertemperatur [°C]	28	
Wasseroberfläche des Beckens [m²]	0	
Luftwechselrate [1/h]	0,8	

Ergebnisse - verdampfte Wassermassenstrom [kg / h]

Parameter	Abgeschlossen	Min. geöffnet	Max. geöffnet
Schwimmbecken ohne Attraktionen	0,37	3,73	14,94
Schwimmbecken mit Attraktionen	0,00	0,00	0,00
Kanal mit Attraktionen	0,00	0,00	0,00
Insgesamt	0,37	3,73	14,94

Ergebnisse - Zuluftstrom

Min. Zuluftmassenstrom [kg/h]	2.819
Min. Zuluftvolumenstrom [m³/h]	2.349

Empfohlene Größe des RLT-Geräts CKL-POOL 30GC

Min. Luftstrom	Nominaler Luftstrom	Max. Luftstrom
2000	3000	3200

© WOLF 2019. Alle Rechte vorbehalten. Die Berechnung und Dokumentation sind ausschließlich für den persönlichen Gebrauch bestimmt. Die Weitergabe oder die Nutzung der Daten ist ohne schriftliche Genehmigung der WOLF GmbH ist ausdrücklich untersagt. Die WOLF GmbH übernimmt keine Verantwortung für die Korrektheit der Berechnungen. * 1: Die Berechnung erfolgt auf Basis der Nennwerte der Geräte. Die Berechnung erfolgt auf Basis der Nennwerte der Geräte. Die Berechnung erfolgt auf Basis der Nennwerte der Geräte.

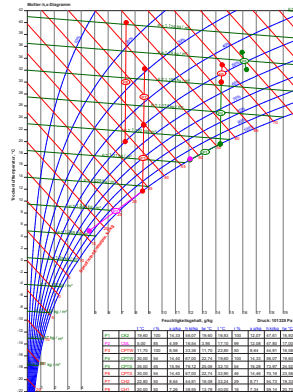
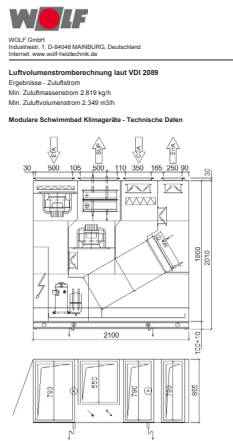

The following documents are provided after performing the calculation based on the VDI guidelines: Specifications of the unit, hx diagram, LV texts and CAD files



Our expert advisers are more than happy to help:

WOLF Energiesystemen
Blauwe Engel 1
8265NL Kampen
+31 38 333 5086
info-nl@wolf.eu

**If you have any questions about this brochure,
please contact us at info-nl@wolf.eu**

Subject to technical modifications. Please note that only the WOLF product is shown in the images of the product. You will usually need incoming and outgoing lines which are connected to the WOLF product from the outside. The WOLF Group makes no guarantees or warranties regarding the accuracy of this brochure. Some images show special accessories.

WOLF GmbH
Postfach 1380
D-84048 Mainburg
Tel. +49 (0)8751 74-0
Email info@wolf.eu
www.wolf.eu



Perfectly in tune with you.

DE/1.22 part.no. 4801253